

Construction

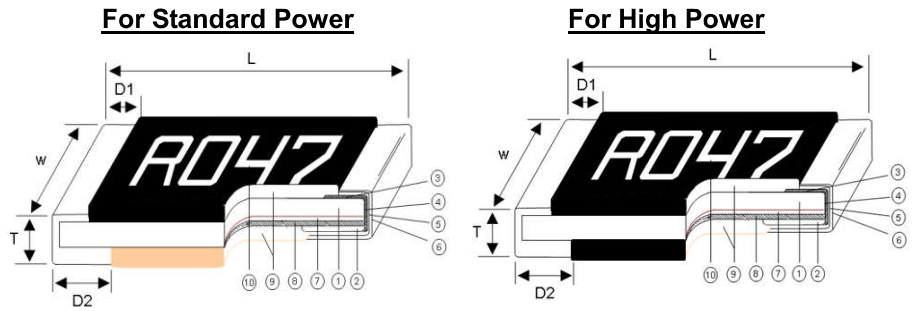

① Alumina Substrate	⑤ Barrier Layer	⑨ Primary Overcoat
② Bottom Electrode	⑥ External Electrode	⑩ Marking
③ Top Electrode	⑦ Adhesive	
④ Edge Electrode	⑧ Resistor Layer	

Features

- SMD Type designed for automatic insertion
- High power rating in small size
- Low resistance resistor for current detection
- Metal foil construction ensures high reliability and performance with very low and stable TCR
- Designed for current sense circuits in power electronic systems
- Pb-Free to meet RoHS requirements
- AEC-Q200 Compliance (only High Power Rating)

Dimensions

Type	Size (Inch)	Resistance Range (mΩ)	L	W	T	D1	D2
CSM02	0402	10 - 50	1.05±0.10	0.55±0.10	0.45±0.10	-	0.27±0.10
CSM03	0603	10 - 29	1.55±0.10	0.85±0.10	0.40±0.10	0.30±0.15	0.45±0.15
		30 - 100	1.55±0.10	0.85±0.10	0.40±0.10	0.30±0.15	0.35±0.15
		10 - 100 (1/2W)	1.70±0.15	1.00±0.15	0.62±0.15	0.35±0.25	0.35±0.25
CSM05	0805	10 - 29	2.00±0.15	1.25±0.15	0.55±0.10	0.30±0.20	0.50±0.20
		30 - 100	2.00±0.15	1.25±0.15	0.52±0.10	0.30±0.20	0.35±0.20
		10 - 100 (3/4W)	2.15±0.15	1.40±0.15	0.75±0.15	0.40±0.25	0.40±0.25
CSM06	1206	10 - 29	3.05±0.15	1.55±0.15	0.58±0.15	0.50±0.25	0.90±0.25
		30 - 100	3.05±0.15	1.55±0.15	0.55±0.15	0.50±0.25	0.60±0.25
		10 - 100 (1W)	3.20±0.15	1.70±0.15	0.75±0.15	0.50±0.25	0.50±0.25
CSM10	2010	10 - 29	5.00±0.20	2.50±0.20	0.58±0.15	0.60±0.30	1.50±0.30
		30 - 100	5.00±0.20	2.50±0.20	0.55±0.15	0.60±0.30	0.90±0.30
CSM12	2512	10 - 29	6.30±0.20	3.15±0.20	0.58±0.15	0.60±0.30	1.80±0.30
		30 - 100	6.30±0.20	3.15±0.20	0.55±0.15	0.60±0.30	1.20±0.30

Applications

- Power Management Applications
- Switching Power Supply
- Over Current Protection in Audio Applications
- Voltage Regulation Module (VRM)
- DC-DC Converter, Battery Pack, Charger, Adaptor

Part Numbering

CSM	06	F	T	E	U	R100	
Product Type	Dimensions (L×W)	Resistance Tolerance	Packaging Code	TCR (PPM/°C)	Power Rating	Resistance	Marking
	02: 0402 03: 0603 05: 0805 06: 1206 10: 2010 12: 2512	D: ±0.5% F: ±1% G: ±2% J: ±5%	T: Taping Reel	D: ±50 E: ±100 F: ±200	W: 1/8W V: 1/4W U: 1/2W Q: 3/4W T: 1W A: 1.5W S: 2W	R010: 0.01Ω R100: 0.1Ω	: Standard N: No Marking

Derating Curve

For Standard Power

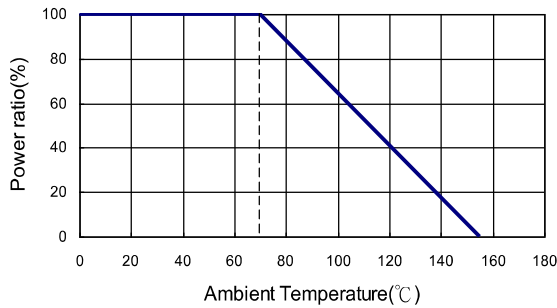

For High Power

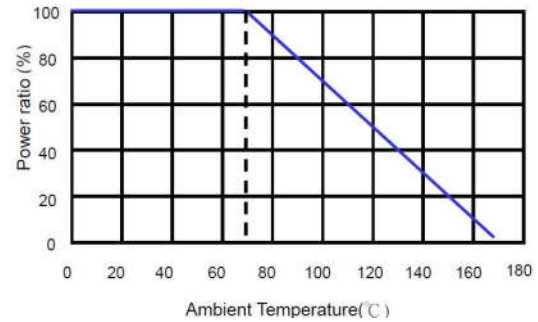

Standard Electrical Specifications

Type	Item	Power Rating at 70°C	Operating Temp. Range	Resistance Range (mΩ)				TCR (PPM/°C)
				±0.5%	±1%	±2%	±5%	
CSM03 (0603)	1/8W			-	10 - 19		±100	
					20 - 100		±50 ±100	
CSM05 (0805)	1/4W			-	10 - 19		±100	
					30 - 100	20 - 100		±50 ±100
CSM06 (1206)	1/2W		-55 ~ +155°C	-	10 - 19		±100	
					30 - 100	20 - 100		±50 ±100
CSM10 (2010)	3/4W			-	10 - 19		±100	
					30 - 100	20 - 100		±50 ±100
CSM12 (2512)	1W			-	10 - 19		±100	
					30 - 100	20 - 100		±50 ±100

High Power Rating Electrical Specifications

Type	Item	Power Rating at 70°C	Operating Temp. Range	Max. Overload Current	Resistance Range (mΩ)			TCR (PPM/°C)
					±1%	±2%	±5%	
CSM02 (0402)	1/4W		-55 ~ +170°C	11.2A	10 - 50			±100
CSM03 (0603)	1/2W			15.8A	10 - 100			±100
CSM05 (0805)	3/4W			19.4A	10 - 100			±50
CSM06 (1206)	1W			22.4A	10 - 100			±50

Operating Voltage= $\sqrt{P \cdot R}$; Overload Voltage= $2.5 \cdot \sqrt{P \cdot R}$; Operating Current= $\sqrt{P/R}$

■ Viking is capable of manufacturing the optional spec based on customer's requirement.

■ Environmental Characteristics

For Standard Series

Item	Requirement	Test Method
Temperature Coefficient of Resistance (T.C.R.)	As Spec.	At 25°C/-55°C and 25°C/+125°C, 25°C is the reference temperature
Short Time Overload	±(0.5%+0.05Ω)	5* Rated Power for 5 seconds
Insulation Resistance	≥ 10G	Max. Overload Voltage for 1 minute
Endurance	±(1.0%+0.05Ω)	70±2°C, RCWV for 1000 hrs with 1.5 hrs "ON" and 0.5 hr "OFF"
Damp Heat with Load	±(1.0%+0.05Ω)	40±2°C, 90~95% R.H., RCWV for 1000 hrs with 1.5 hrs "ON" and 0.5 hr "OFF"
Dry Heat	±(0.5%+0.05Ω)	at +155°C for 1000 hrs
Bending Strength	±(1.0%+0.05Ω)	Bending once for 5 seconds 2010, 2512 sizes: 2mm Other sizes: 3mm
Solderability	95% min. coverage	245±5°C for 3 seconds
Resistance to Soldering Heat	±(0.5%+0.05Ω)	260±5°C for 10 seconds
Voltage Proof	No breakdown or flashover	1.42 times Max. Operating Voltage for 1 minute
Leaching	Individual leaching area ≤ 5% Total leaching area ≤ 10%	260±5°C for 30 seconds
Rapid Change of Temperature	±(0.5%+0.05Ω)	-55°C to +155°C, 5 cycles

RCWV(Rated Continuous Working Voltage)= $\sqrt{P \cdot R}$ or Max. Operating Voltage whichever is lower.

■ Reference Standards: IEC 60115-1, 60068-2-58; JIS-C 5201-1

■ Storage Temperature: 15~28°C; Humidity < 80%RH

■ Environmental Characteristics

For High Power Rating Series

Item	Requirement	Test Method
Temperature Coefficient of Resistance (T.C.R.)	As Spec.	-55°C~+125°C, 25°C is the reference temperature
Short Time Overload	$\Delta R \leq \pm 1\%R$	2512 sizes: 4* Rated Power for 5 seconds Other sizes: 5* Rated Power for 5 seconds
Insulation Resistance	$\geq 1000M\Omega$	Max. Overload Voltage for 1 minute
Operational Life	$\Delta R \leq \pm 1\%R$	Condition D Steady State $T_A=125^\circ\text{C}$ at derated power. Measurement at 24±4 hours after test conclusion
Biased Humidity	$\Delta R \leq \pm 1\%R$	85°C/85RH., 1000 hrs, apply 10% of operating power (current) or limiting element current whichever is lower
High Temperature Exposure	$\Delta R \leq \pm 1\%R$	at +155°C for 1000 hrs
Temperature Cycling	$\Delta R \leq \pm 1\%R$	-55°C to +125°C, 1000 cycles
Bending Strength (Board Flex)	$\Delta R \leq \pm 1\%R$	Bending once for 60 seconds
Solderability	95% min. coverage	245±5°C for 3 seconds
Resistance to Soldering Heat	$\Delta R \leq \pm 1\%R$	260±5°C for 10 seconds
Voltage Proof	No breakdown or flashover	1.42 times Max. Operating Voltage for 1 minute
Resistance to solvents	Marking Unsmearred	Add Aqueous wash chemical - OKEM Clean or equivalent. Do not use banned solvents.
Mechanical Shock	$\Delta R \leq \pm 1\%R$	Wave Form: Tolerance for half sine shock pulse. Peak value is 100g's. Normal duration (D) is 6.
Vibration	$\Delta R \leq \pm 1\%R$	5 g's for 20 min., 12 cycles each of 3 orientations, 10-2000 Hz
ESD	$\Delta R \leq \pm 1\%R$	Human body model 0402 sizes: 1KV Other sizes: 2KV
Flammability	No ignition of the tissue paper or scorching or the pinewood board	V-0 or V-1 are acceptable. Electrical test not required.
Terminal strength	No broken	Force of 1.8kg for 60 seconds

RCWV(Rated Continuous Working Voltage)= $\sqrt{P \cdot R}$ or Max. Operating Voltage whichever is lower.

■ Reference Standards: IEC 60115-1, JIS-C 5201-1, AEC-Q200, MIL-STD-202, UL-94

■ Storage Temperature: 15~28°C; Humidity < 80%RH

■ Packaging

Packaging Quantity & Reel Specifications

Unit: mm

Type	ΦA	ΦB	ΦC	W	T	Paper Tape (EA)	Emboss Plastic Tape (EA)
CSM02	178.0±1.0	60.0+1.0	13.5±0.7	9.5±0.1	11.5±1.0	10,000	-
CSM03	178.0±1.0	60.0+1.0	13.5±0.7	9.5±0.1	11.5±1.0	5,000	-
CSM05	178.0±1.0	60.0+1.0	13.5±0.7	9.5±0.1	11.5±1.0	5,000	-
CSM06	178.0±1.0	60.0+1.0	13.5±0.7	9.5±0.1	11.5±1.0	5,000	-
CSM10	178.0±1.0	60.0+1.0	13.5±0.7	13.5±1.0	15.5±1.0	-	4,000
CSM12	178.0±1.0	60.0+1.0	13.5±0.7	13.5±1.0	15.5±1.0	-	4,000

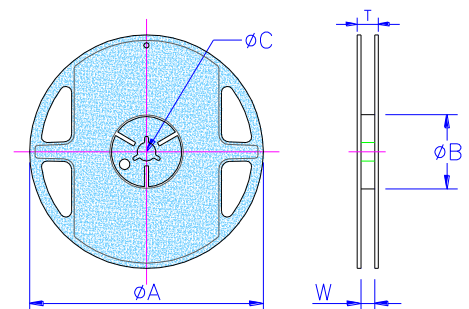

Current Sensing Metal Chip Resistor

Paper Tape Specifications

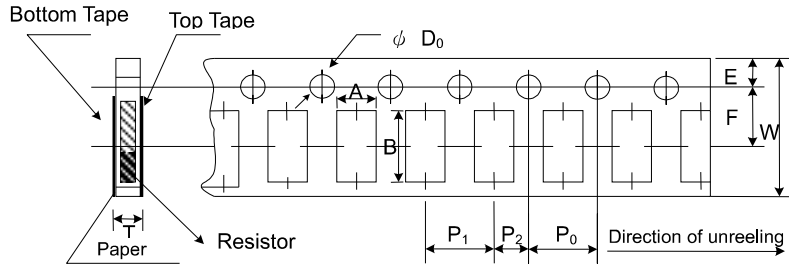

Unit: mm

Type	A	B	W	E	F	P ₀	P ₁	P ₂	ΦD ₀	T
CSM02 (1/4W)	0.66±0.06	1.18±0.06	8.0±0.20	1.75±0.10	3.50±0.05	4.00±0.10	2.00±0.05	2.00±0.05	1.55±0.05	0.60±0.06
CSM03	1.10±0.10	1.90±0.10	8.0±0.20	1.75±0.10	3.50±0.05	4.00±0.10	4.00±0.05	2.00±0.05	1.50+0.1,-0	0.70±0.10
CSM03 (1/2W)	1.10±0.10	1.85±0.10	8.0±0.20	1.75±0.10	3.50±0.05	4.00±0.10	4.00±0.05	2.00±0.05	1.50+0.1,-0	0.60±0.05
CSM05	1.60±0.10	2.40±0.20	8.0±0.20	1.75±0.10	3.50±0.05	4.00±0.10	4.00±0.05	2.00±0.05	1.50+0.1,-0	0.85±0.10
CSM05 (3/4W)	1.60±0.10	2.35±0.20	8.0±0.20	1.75±0.10	3.50±0.05	4.00±0.10	4.00±0.05	2.00±0.05	1.50+0.1,-0	0.95±0.05
CSM06	1.90±0.10	3.50±0.20	8.0±0.20	1.75±0.10	3.50±0.05	4.00±0.10	4.00±0.05	2.00±0.05	1.50+0.1,-0	0.85±0.10
CSM06 (1W)	1.90±0.10	3.50±0.20	8.0±0.20	1.75±0.10	3.50±0.05	4.00±0.10	4.00±0.05	2.00±0.05	1.50+0.1,-0	0.95±0.05

Embossed Plastic Tape Specifications

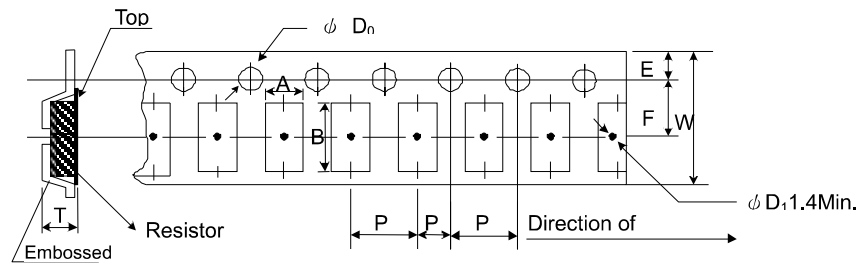

Unit: mm

Type	A	B	W	E	F	P ₀	P ₁	P ₂	ΦD ₀	T
CSM10	2.80±0.10	5.50±0.10	12.0±0.10	1.75±0.10	5.5±0.05	4.00±0.05	4.00±0.10	2.00±0.05	1.50+0.10	1.00±0.20
CSM12	3.50±0.10	6.70±0.10	12.0±0.10	1.75±0.10	5.5±0.05	4.00±0.05	4.00±0.10	2.00±0.05	1.50+0.10	1.00±0.20

Recommend Land Pattern

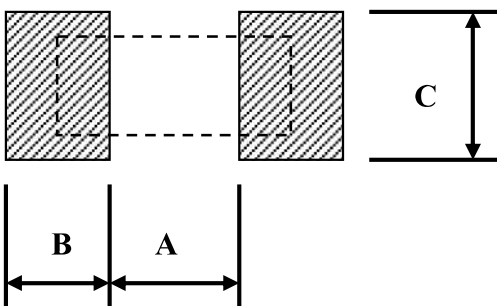

Pad Layout

Type	Resistance Range	A (mm)	B (mm)	C (mm)	t (μm)
CSM02	10-50mΩ	0.50	0.50	0.60	35
CSM03	10-29mΩ	0.40	1.20	0.90	-
	30-100mΩ	0.70	1.05	0.90	-
CSM03(1/2W)	10-100mΩ	0.50	1.00	0.90	35
CSM05	10-29mΩ	0.80	1.10	1.35	-
	30-100mΩ	1.00	1.00	1.35	-
CSM05(3/4W)	10-100mΩ	0.80	1.30	1.30	70
CSM06	10-29mΩ	0.9	1.70	1.70	-
	30-100mΩ	1.50	1.40	1.70	-
CSM06(1W)	10-100mΩ	1.50	1.40	1.70	105
CSM10	10-29mΩ	1.70	2.35	2.50	-
	30-100mΩ	2.80	1.80	2.50	-
CSM12	10-29mΩ	2.30	2.90	3.20	-
	30-100mΩ	3.60	2.25	3.20	-

t: copper foil minimum thickness of PCB